

7. INSTALL STRIKES

A. CLOSE DOOR UNTIL LATCH BOLT TOUCHES DOOR JAMB. MARK DOOR JAMB AS SHOWN WITH A PENCIL.

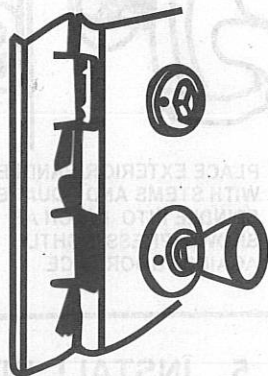

B. CENTER THE STRIKER PLATES ON THE DOOR JAMB WITHIN THE AREAS MARKED IN STEP A.

8. MARK OUTLINE

MARK OUTLINE OF STRIKER PLATE INCLUDING FIXING HOLES. MARK CENTER OF BOLT HOLES FOR DRILLING AS SHOWN.

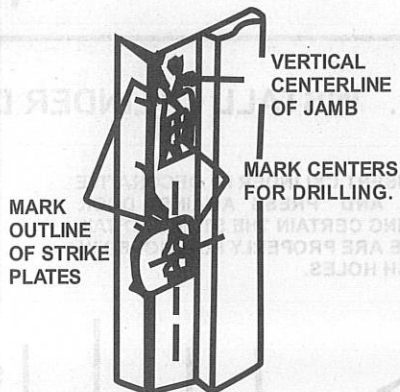

9. DRILL AND INSTALL STRIKERS

1. DRILL 7/8" HOLES IN DOOR JAMB. CAUTION: TO ASSURE PROPER LOCKSET FUNCTION, HOLES IN DOOR JAMB MUST BE DRILLED 1" DEEP.

2. CHISEL OUTLINE FOR STRIKER PLATES 1/16" DEEP OR UNTIL PLATES ARE FLUSH WITH DOOR JAMB.

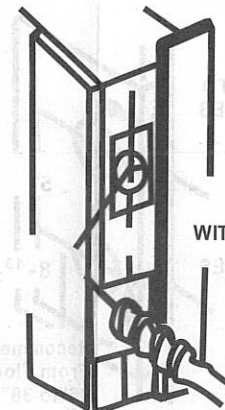

INSTALL STRIKER PLATES AND SECURE WITH THE WOOD SCREWS

— PARTS —

1. CYLINDER & TRIM
2. EXTERIOR HANDLE
3. MATING TRIM
4. INTERIOR KNOB
5. UPPER LATCH
6. LOWER LATCH
7. UPPER STRIKER PLATE
8. LOWER STRIKER PLATE
9. MACHINE SCREW
10. WASHER
11. WOOD SCREW

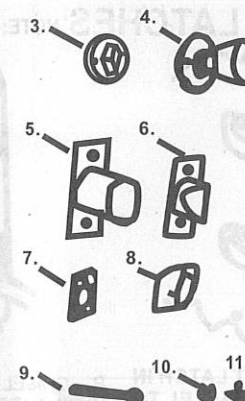
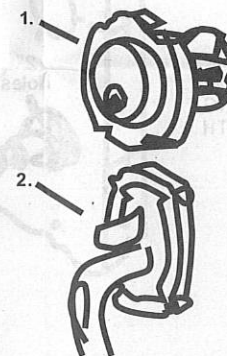

INSTALLATION INSTRUCTIONS

1. MARK DOOR

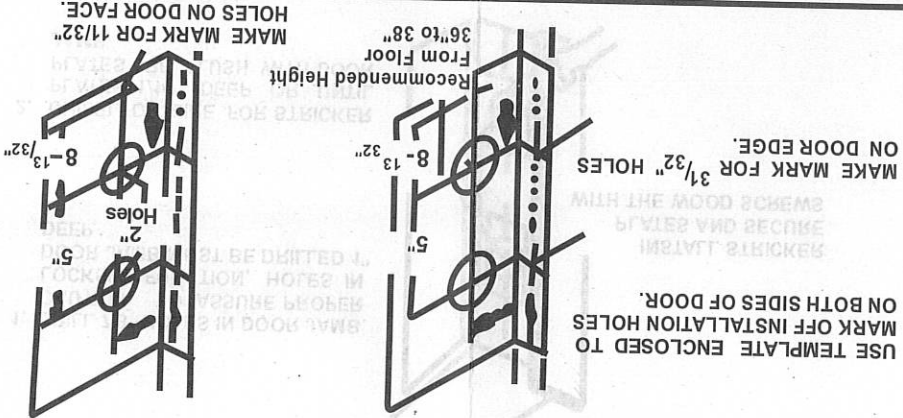

2. DRILL HOLES

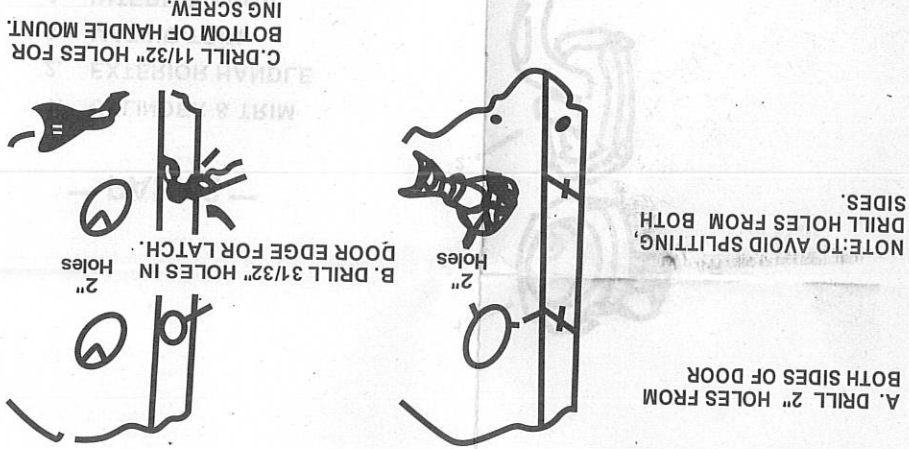

3. INSTALL LATCHES

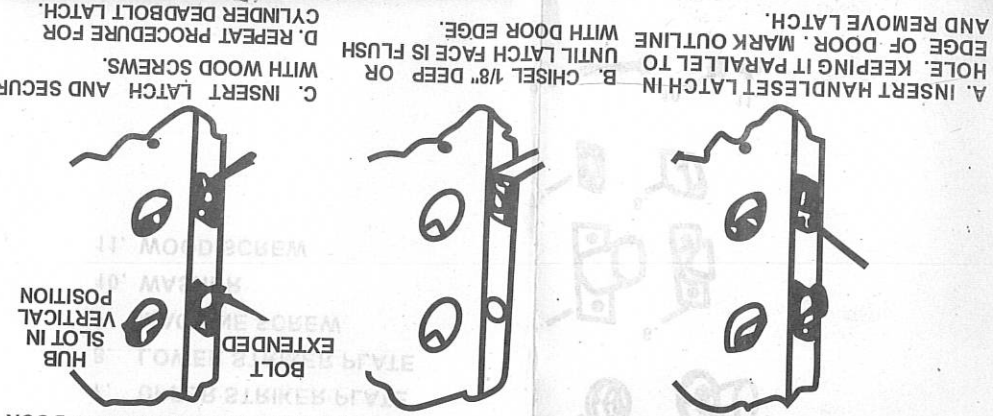

4. INSTALL EXTERIOR HANDLE MECHANISM

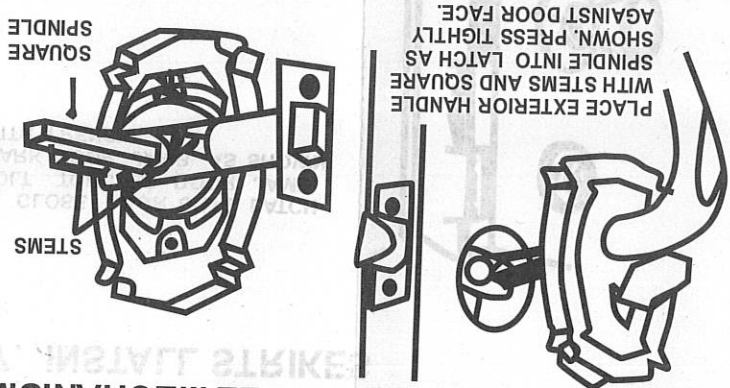

5. INSTALL INTERIOR KNOBS

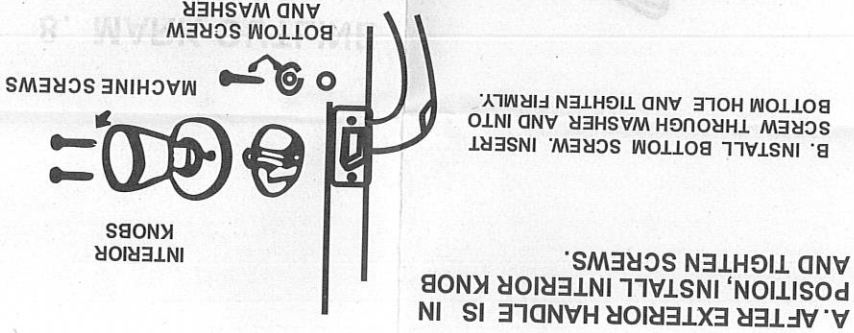

6. INSTALL CYLINDER DEADLOCK AND TRIM

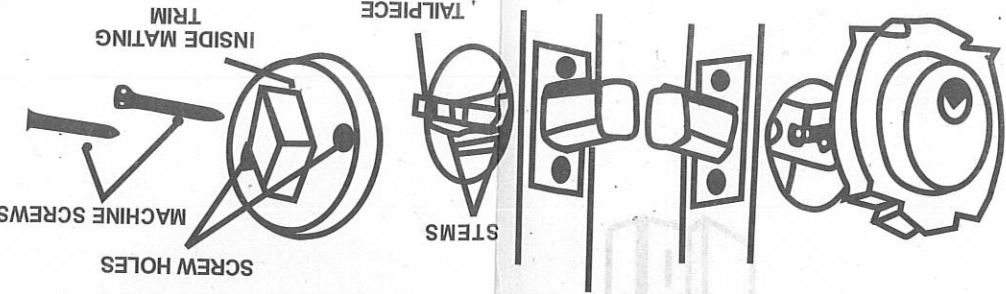
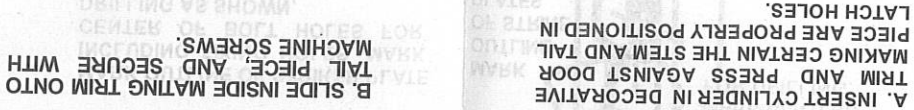

TEMPLATE

Fit here on door edge

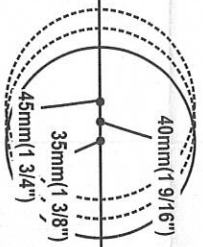

Make 25mm (1") and 85mm (3 3/8") deep hole in the center of door edge.

BACKSET 70mm (2 3/4")

BACKSET 60mm (2 3/8")

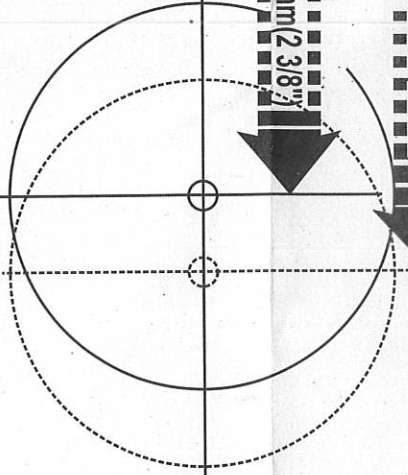

Make 51mm (2") hole

CENTER TO CENTER 127mm (5")

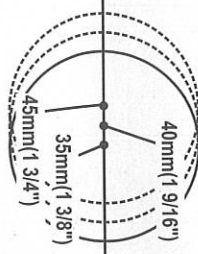

Make 25mm (1") and 85mm (3 3/8") deep hole in the center of door edge.

Height 915mm (36") from floor

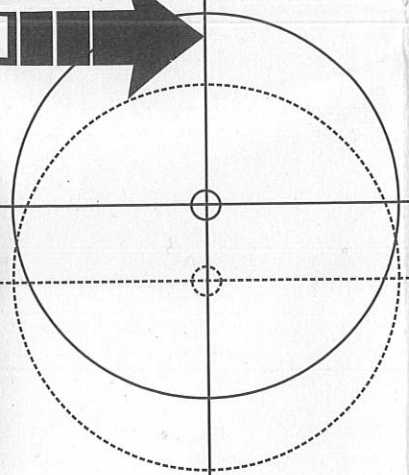

Make 51mm (2") hole

BACKSET 214mm (8 2/5")



Make 8mm (5/16") hole

