

RVH7115

UNDERMOUNT WORKSTATION SINK

RUVATI[®]
SPECIFICATION SHEET

MATERIAL

True 16 Gauge Thickness
Premium T304 Grade Stainless Steel
18/10 Chromium/Nickel Content
Commercial Brushed Finish

FEATURES

- Heavy duty sound guard padding and undercoating
- Slanted bottom with elegant drain grooves for easy draining
- Small size sink for wet bar

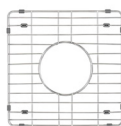

IN THE BOX



Basket Strainer
[RVA1025]

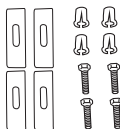

Mounting Clips
[RVA11031]



Cut-out
Template



Rinse Grid
[RVA67115]

NOMINAL DIMENSIONS

Exterior: 15" (wide) x 15" (front-to-back)
Interior Bowl: 13" (wide) x 13" (front-to-back)
Bowl Depth: 9"
Minimum Cabinet Size: 18" wide
Drain Hole Size: 3½"

Installation Type:
Undermount

Inside Corners:
Zero Radius

Drain Location:
Rear Center

RUVATI USA
www.ruvati.com

Phone: 1.855.478.8284
Email: support@ruvati.com

OPTIONAL ACCESSORIES (SOLD SEPARATELY)



Deep Basket
Disposal Flange
[RVA1049ST]



Drain Cover
[RVA1035]

DIMENSIONS

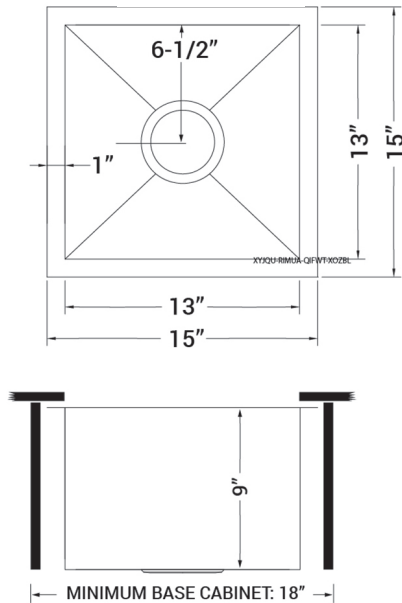

Register your product at www.ruvati.com/register.