



Sink - TARA

Three-hole lavatory mixer with drain - Brushed Chrome

Article number: 20 710 882-93 0010

Date of manufacture from 6/25/2021



- 5-3/8" Projection
- US drain with overflow
- Swiveling spout 360°
- Round aerated stream
- Total height 10-5/8"
- Height to aerator/spout outlet 6-3/8"
- Valve hole diameter 1-1/4"
- Spout hole diameter 1-3/8"
- Flange diameter 2-1/8"
- 2x 3/8" flexible supply lines
- Water flow rate limited to max. 1.2 gpm
- lead-free

Codes & Standards

- NSF/ANSI 372
- California Energy Commission (CEC)
- ASME A112.18.1/CSA B125.1
- NSF/ANSI/CAN 61
- ADA

- (ADA)
- Suitable only for basins with overflow.



Brushed Chrome



Sink - TARA

Three-hole lavatory mixer with drain - Brushed Chrome

Article number: 20 710 882-93 0010

Date of manufacture from 6/25/2021

Dimensional drawing

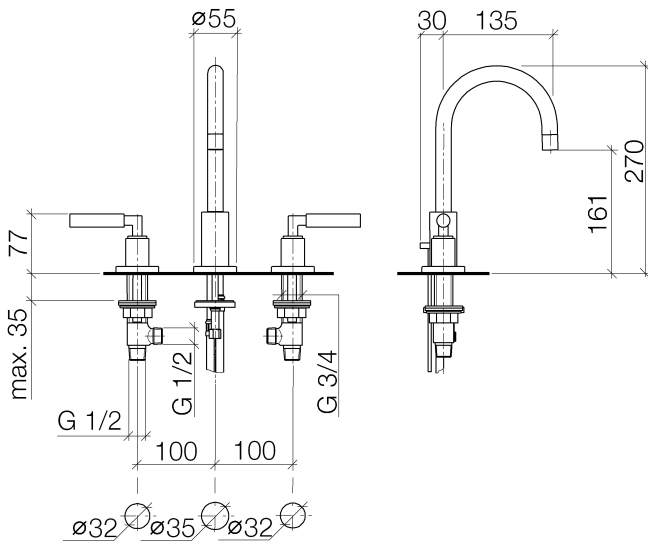

All dimensions in mm / inch = mm x 0,0394

Flow rate chart

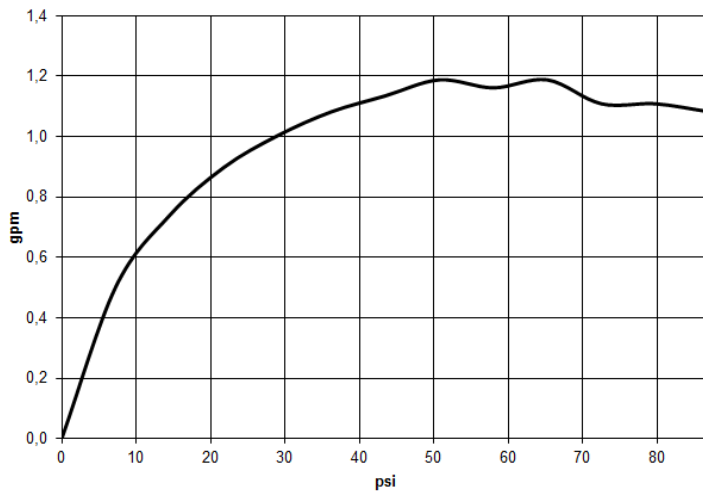



Sink - TARA

Three-hole lavatory mixer with drain - Brushed Chrome

Article number: 20 710 882-93 0010

Date of manufacture from 6/25/2021

Other surface finishes



Chrome

20 710 882-00 0010



Brushed Platinum

20 710 882-06 0010



Platinum

20 710 882-08 0010



White matte

20 710 882-10 0010



Brushed brass (23kt gold)

20 710 882-28 0010

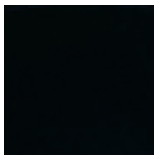

Black matte

20 710 882-33 0010



Brushed champagne (22kt gold)

20 710 882-46 0010



Champagne (22kt Gold)

20 710 882-47 0010



Brushed Dark Platinum

20 710 882-99 0010

More custom finish options are available via special production (xTra Service). See our finish matrix for availability and pricing or contact a Dornbracht representative. Some series may be excluded and some finishes may not be available in all series.

Sink - TARA

Three-hole lavatory mixer with drain - Brushed Chrome

Article number: 20 710 882-93 0010

Date of manufacture from 6/25/2021

Spare parts list

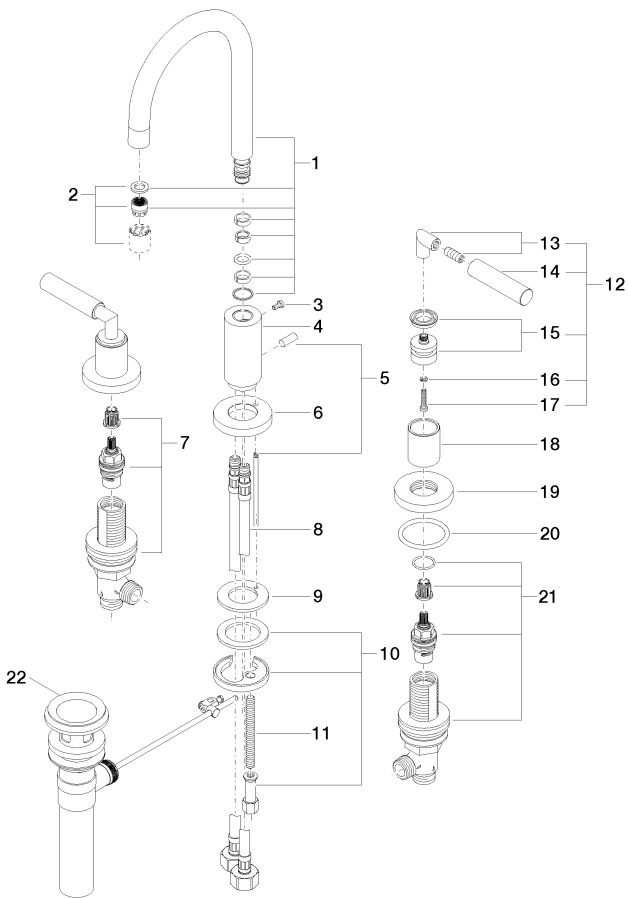

Number	Item Number	Designation	Number of units
1	90 28 22 217 02-93	spout	1
2	90 23 01 028 04-93	aerator	1
3	09 30 30 057 90	screw	1
4	09 11 10 087 10-93	connection	1
5	04 20 89 030 80-93	pull-rod	1
6	09 28 10 133-93	ring	1
7	90 17 11 040 51 90	side panel	1
8	04 30 04 019 00 90	hose	2
9	09 14 05 047 90	seal	1
10	04 30 11 038 00 90	fixing set	1
11	09 31 11 011 90	pin	1
12	04 20 88 052 00-93	handle	2
13	04 18 20 022 00-93	angle	2
14	09 20 88 052-93	handle	2
15	90 12 12 007 00-93	base	2
16	09 30 11 029 90	disc	2
17	09 30 30 075 90	screw	2
18	09 21 02 140-93	sleeve	2
19	09 27 89 105-93	rosette	2
20	09 14 10 043 90	seal	2
21	90 17 11 040 50 90	side panel	1
22	04 11 01 023 00-93	Drain US 1 1/4" - Brushed Chrome	1